

**ALITHERM 300 CASEMENT WALL CHART ANCILLARY PROFILES**

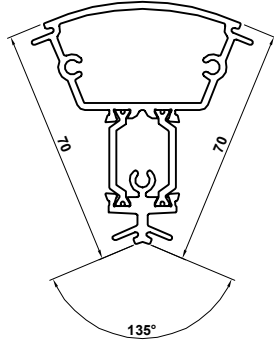

**ETC385**  
 135° Corner Post

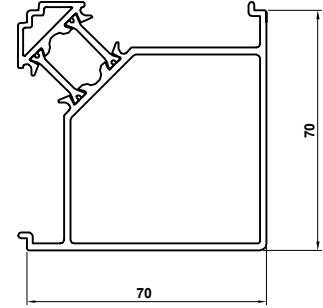

**ETC048**  
 Corner Post

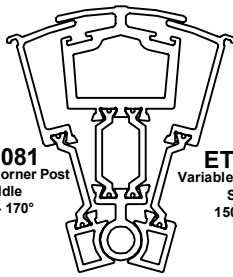

**ETC081**  
 Variable Corner Post Saddle  
 150° - 170°



**ETC081**  
 Variable Corner Post Saddle  
 150° - 170°

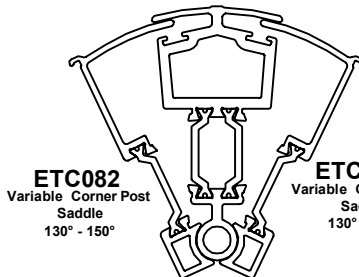

**ETC082**  
 Variable Corner Post Saddle  
 130° - 150°

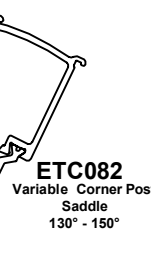

**ETC082**  
 Variable Corner Post Saddle  
 130° - 150°

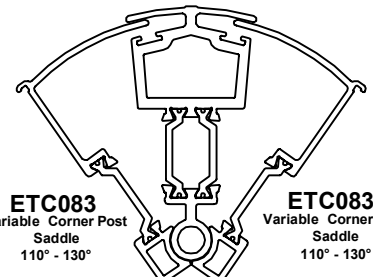

**ETC083**  
 Variable Corner Post Saddle  
 110° - 130°



**ETC083**  
 Variable Corner Post Saddle  
 110° - 130°

**ETC080**  
 Variable Corner Post Center

**ETC080**  
 Variable Corner Post Center

**ETC080**  
 Variable Corner Post Center

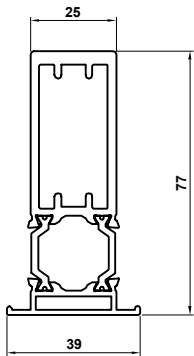

**ETC517**  
 Coupler

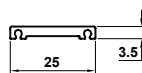

**W20165**  
 Astragal Bar

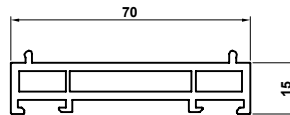

**3637**  
 PVC Frame Packer

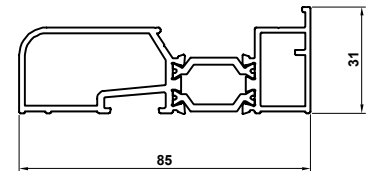

**ETC451**  
 85mm Stub Cill

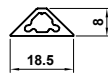

**AM603**  
 Astragal Bar

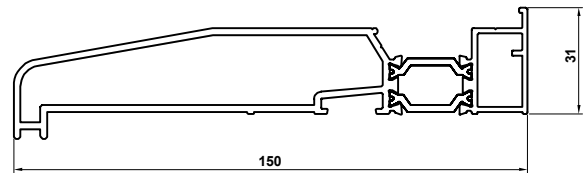

**ETC457**  
 150mm Cill

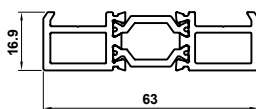

**ETD052**  
 Coupler

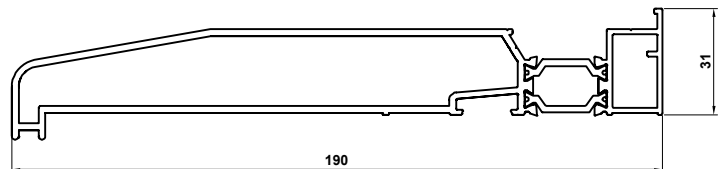

**ETC458**  
 190mm Cill

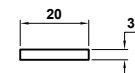

20mm Flat Trim

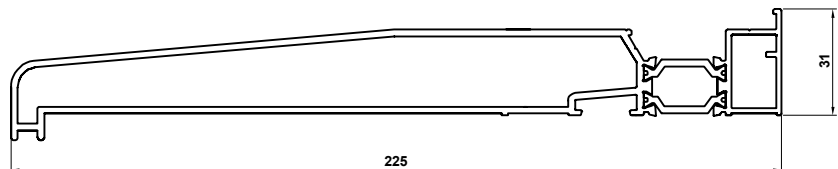

**ETC479**  
 225mm Cill